

Thank you for purchasing the Luxi Electronics® Presenter product. Please read through this manual before using the product.

How the product functions: Think of the daisy chain as the flow of a river; each transmitter (Tx) connects to a source device and loads the signal to the river flow; each receiver (Rx) unloads the signal from the river flow and sends it to the display it is connected to. The front panel and the RS-232 controls determine which source signal goes to which display.

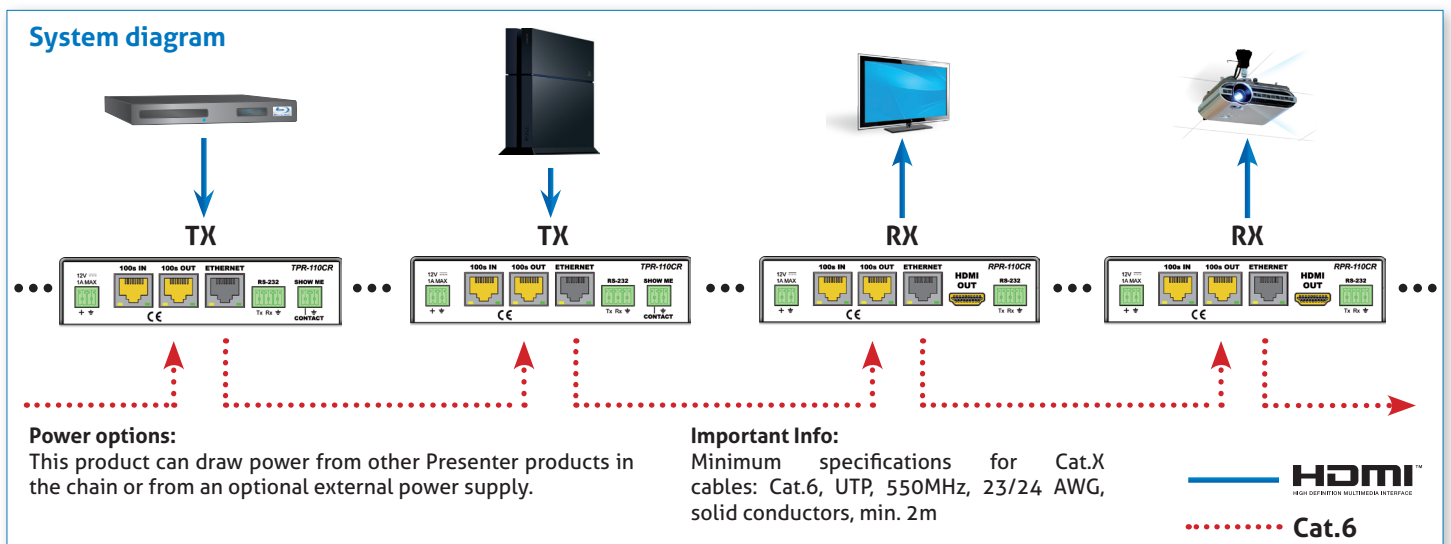

Captive screw plug termination

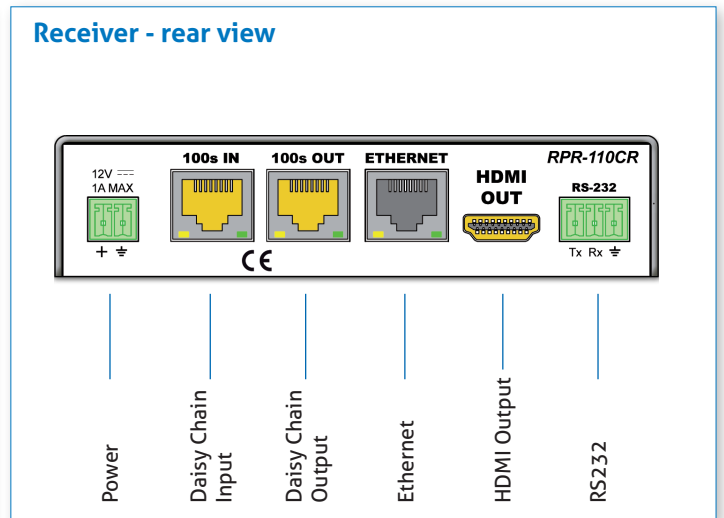
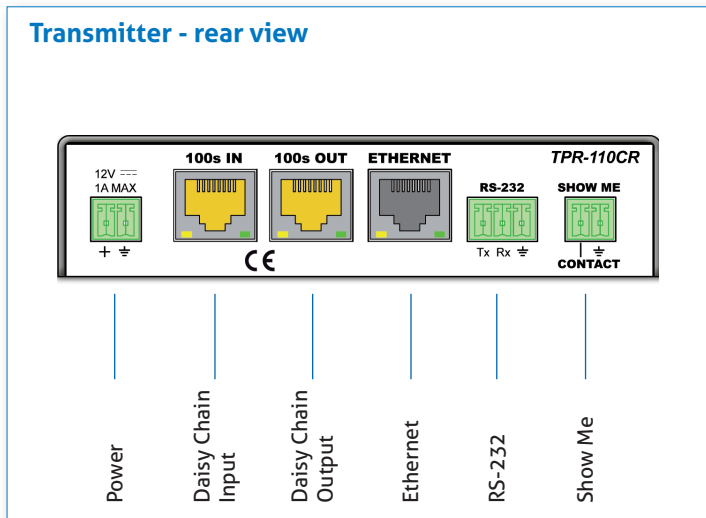
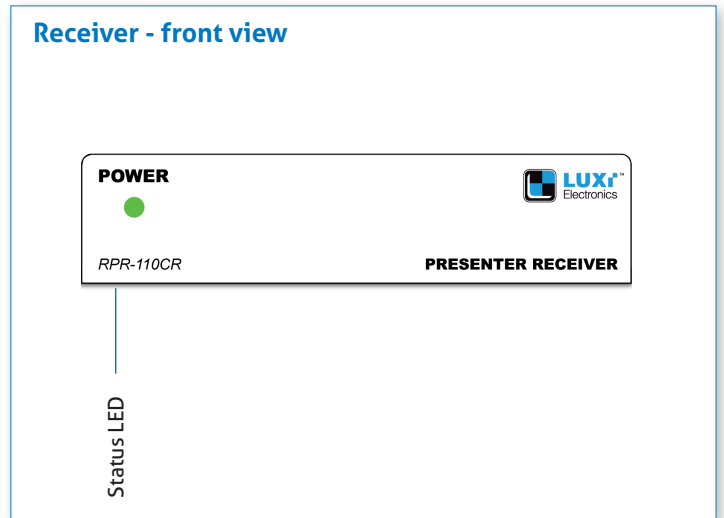
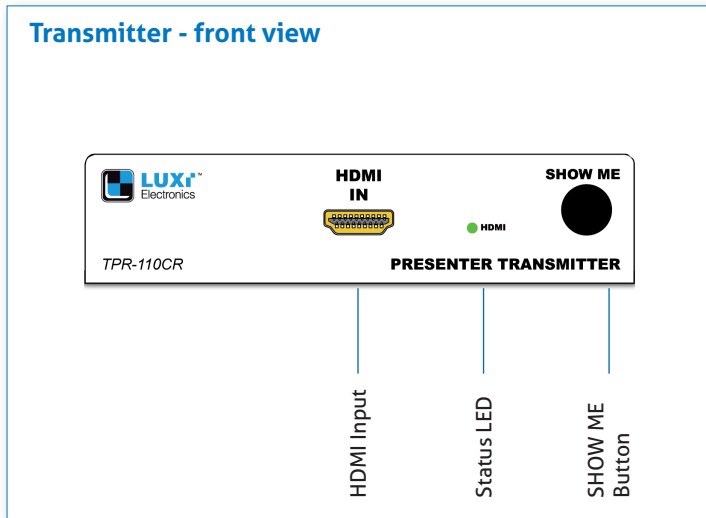
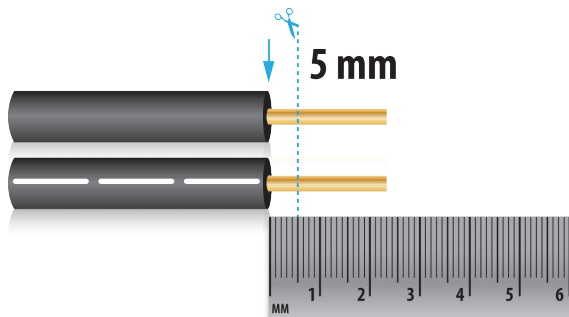

The captive screw plugs for power, RS-232 and contact controls are supplied with the unit. Separate the wires about 2.5 cm long; strip off the wire insulation precisely 5 mm from the end.

Captive screw plug termination

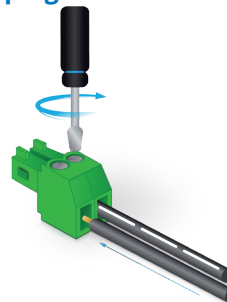

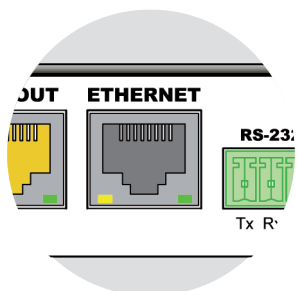

Identify the positive and negative leads of the power supply before assembly. When using a 3rd party PSU this must be checked before assembly. **CAUTION - always confirm your PSU connection with a multimeter before inserting it into the product - a miswired connection will cause damage to the product and void the warranty!!**

Ethernet port



For providing a system wide internet access. **Be very careful NOT to plug the Ethernet cable into the yellow 100s connector or vice versa!** Permanent damage may occur.

Front panel LED

-  This Presenter is selected.
-  This Presenter is not selected.
-  Communication error.

RJ45 plug termination

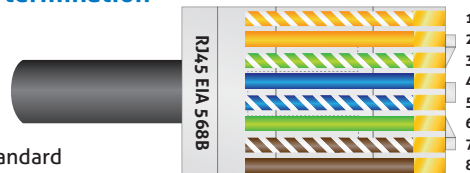

Follow the standard EIA 568B pin out.

TRANSMITTER control options

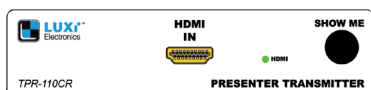

Pressing the "Show Me" button on the front panel will select the source connected to this Tx unit; all displays will show the same content from this Tx box. An external button can be connected to the "Show Me" port on the rear panel. An RS-232 host connected to the rear panel can control all functions of every unit in the chain. Make sure both DIP switches recessed on the bottom side are in the down (off) position.

RECEIVER control options



A RS-232 host connected to the rear panel can control all functions of every unit in the chain. Make sure both DIP switches recessed on the bottom side are in the down (off) position.

Minimum system

One Tx and one Rx connected with a Cat.6 cable (min at.6, UTP, 550MHz, 23/24 AWG, solid conductors, min. 2m). Use the minimum system to test all devices and cables to be used in bigger systems first, in order to isolate any potential problems.

Support

Please contact your reseller directly for local support. See PureLink website for RS-232 commands and user manuals.